

Datasheet MBZ 204 F 900

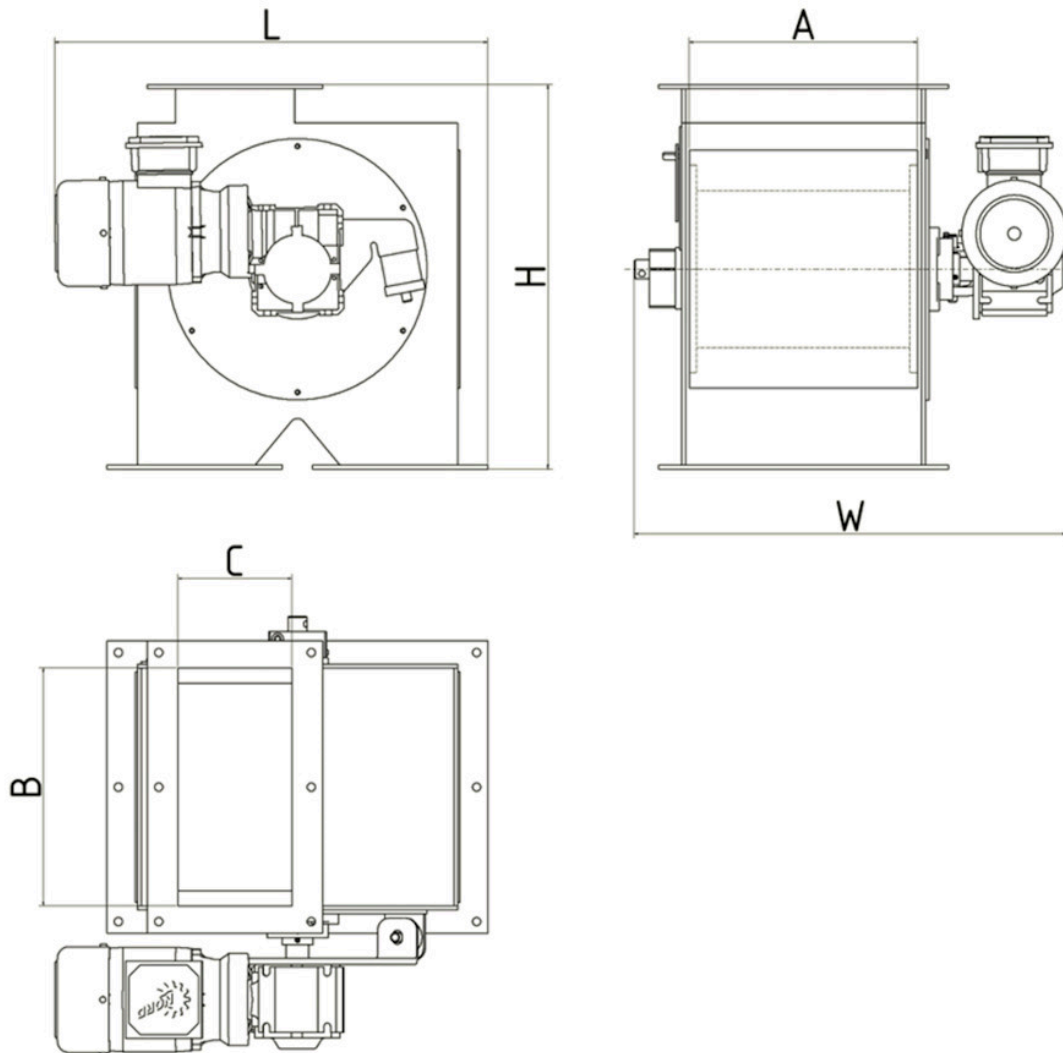

Model	Flow capacity (m ³ /h)	Weight (kg)	Dimensions (mm)					
			A	B	C	W	L	H
MBZ 204 F 200	20	110	200	210	150	490	570	500
MBZ 204 F 300	25	140	300	310	150	590	570	500
MBZ 204 F 400	30	185	400	410	150	690	570	500
MBZ 204 F 500	35	220	500	510	150	790	570	500
MBZ 204 F 600	40	270	600	610	150	890	570	500
MBZ 204 F 700	45	320	700	710	150	990	570	500
MBZ 204 F 800	50	370	800	810	150	1090	570	500
MBZ 204 F 900	60	420	900	910	150	1190	570	500

MBZ 204 F 1000	75	470	1000	1010	150	1290	570	500
----------------	----	-----	------	------	-----	------	-----	-----

Parameter name	Value
Description:	Magnetic drum in a housing
Separator placement:	under the conveyor belt, under the feeding hopper, inside of a pipeline
Application (= the material that the application of this separator is suitable for):	bulk material
Material flow direction):	vertical, horizontal
Recommended for the belt of max. width (across the conveyor belt) (mm):	900
Maximum effective reach of the magnetic field (mm):	30
Built-in standard magnet type:	ferrite magnet
Max. magnetic induction (G) on the surface of tube (+/- 10 %):	1450
Magnetic flux (G) on the magnetic core (+/- 10 %):	2800
Maximum capacity. The mentioned capacities are informative and non binding (m ³ /h):	60
Weight of the separator (kg):	420
Connecting dimension, inlet and outlet diameter of the separator (mm):	900
Standard connection of the separator:	square flange, suspension holes
Separator is suitable also even for the materials of poor bulk properties:	yes
Minimum size of the particles that can be captured by the separator (mm):	1.5
Maximum size of the particles that can be captured by the separator (mm):	50
Max. operating temperature (°C):	100
Min. surrounding ambient temperature (°C):	-25
Max. surrounding ambient temperature (°C):	45
Material of the sealing:	silicone + NBR
Separator is suitable for vacuum or pressure conveying lines:	no
Separator is suitable for materials transported by:	conveyor belt, gravity, pipeline
Separator is able to capture paramagnetic particles:	no

Separator is suitable for abrasive materials (1 = strongly abrasive, 2 = slightly abrasive, 3 = non-abrasive):	2
Separator is suitable for materials that tend to solidify (the materials must be heated):	no
Separation of non-ferrous metals:	no
Standard requirements for the installation:	electricity supply corresponding with the motor parameters
Cleaning of the separator:	fully automatic cleaning, it is not necessary to interrupt the material flow during the cleaning
Material of the separator body (that is in contact with the material):	DIN 1.4301
ATEX (on request):	zone 21, 22
Outer surface treatment of the separator:	sandblasted
Inner surface treatment of the separator:	clean steel (no surface treatment) + sandblasted
Magnetic system:	magnetic drum
Motor brand:	Nord
Main motor input (kW):	0.18
Definition of the main motor electrical connection:	400 V, AC, 50 Hz, , PE-N, TN-C-S, circuite breaker 3F/32A
Available motor variants (the variant mentioned as the first is the standard one):	electric motor
Degree of motor protection (against dust and water):	IP55
Rotational speed of the engine (rev/min):	28
Bearings:	SNR
Availble lubrication methods for the bearings:	manual
Standard electrical equipment of the separator:	no external electric cable, no frequency convertor, no electric switchboard, wiring is terminated at the motor screw terminal
Options of the extended anti-abrasion protection:	chemical nickel coating, plastic coating, rubberizing, ceramic lining
Other standard parameters:	adjustable material distributor
Other additionally paid options:	device for manual setting of the position of the magnetic core, dust extraction opening, inner polishing
Max. operation time (hours/day):	24
Max. production time for a standard version (if not available in stock) (weeks):	8
Standard packing:	pallet + stretch wrap

Other packing modes (surcharged options):	wooden box, maritime packing according to clients needs
Warranty (months):	60
The guarantee does not apply to:	driveline, bearings, magnetic drum surface, wear parts (rubber dampers, seals)

This product can be delivered also in different dimensions, in the versions with a higher temperature resistance, different magnets etc. upon a special request. The mentioned capacity is only approximative and depends on the type of the cleaned material. The maximum effective reach of the magnetic field is measured from the surface of the magnetic drum. Maximum material limit (MMC): 50 x 50 x 50 mm