

Datasheet ML-P 150 N

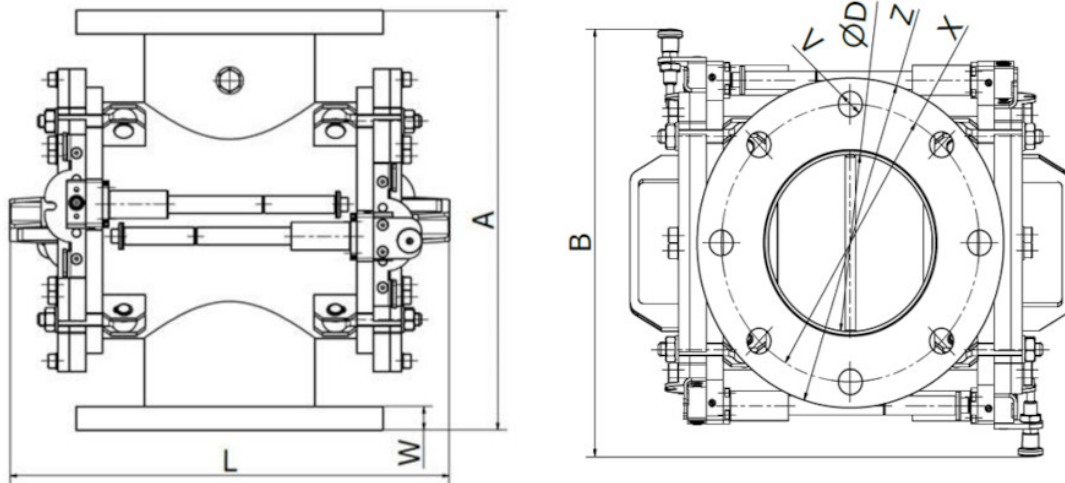

			Dimensions (mm)			
Model	Max. flow capacity (m ³ /h)	Weight (kg)	A	L	B	ØD
ML-P 100 N	10	51	310	360	326	100
ML-P 150 N	30	76	390	410	375	150
ML-P 200 N	75	107	454	460	435	200
ML-P 250 N	100	141	510	510	485	250
ML-P 300 N	120	206	560	610	520	300
ML-P 350 N	150	240	600	660	550	350

Dimensions of standard flanges

		Dimensions (mm)				
Flange type	Number of holes	V	W	X	ØD	Z
DN 100	8	18	20	180	100	220
DN 150	8	22	22	240	150	285
DN 200	8	22	24	295	200	340
DN 250	12	22	26	350	250	395
DN 300	12	22	26	400	300	445
DN 350	16	22	30	460	350	505

Parameter name	Value
Description:	Pressure chute magnet for vacuum and pressure pipelines
Separator placement:	inside of a pipeline
Material flow direction (beginning with the most common one):	vertical, horizontal
Max. magnetic induction (depending on the type of the separator it is either a magnetic value on the surface of the separator or a magnetic value that is in direct contact with the treated material. Tolerance +/- 10 %):	7500
Weight of the separator (kg):	76
Connecting dimension, inlet and outlet diameter of the separator (mm):	150
Application (= the material that the application of this separator is suitable for):	liquid material, semi-fluid material, bulk material
Separator is suitable also even for the materials of poor bulk properties:	yes
Minimum size of the particles that can be captured by the separator (mm):	0.5
Maximum size of the particles that can be captured by the separator (mm):	30
Separator is suitable for vacuum or pressure conveying lines:	up to 10 bars
Separator is suitable for materials transported by:	pipeline
Max. speed at which that the separator can capture ferrous particles (m/s):	25
Separator is able to capture paramagnetic particles:	yes
Separator is suitable for abrasive materials (1 = strongly abrasive, 2 = slightly abrasive, 3 = non-abrasive):	2
Separator is suitable for materials that tend to solidify (the materials must be heated):	no
Separation of non-ferrous metals:	no
Cleaning of the separator:	manual cleaning (without easy cleaning system), a need of interrupting the material flow
Max. operating temperature/ max. temperature of the material (°C):	80
Min. surrounding ambient temperature (°C):	-25
Max. surrounding ambient temperature (°C):	45

Built-in standard magnet type	neodymium magnet N35
Material of the sealing (it regards only some separators):	silicone
Maximum capacity. The mentioned capacities are informative and non binding (m3/h):	30
Options of the extended anti-abrasion protection:	chemical nickel coating, plastic coating, rubberizing, ceramic lining, chromium plating
Material of the separator body (that is in contact with the treated material):	DIN 1.4301
ATEX specification (number):	20, 21, 22
Outer surface treatment of the separator:	sandblasted, partially painted (RAL colour tone)
Inner surface treatment of the separator:	sandblasted
Magnetic system:	magnetic plate
Connection possibilities of the separator (the variant mentioned as the first is the standard one):	standard flange
Other additionally paid options (beside the already mentioned options referring to the anti-abrasion protection, motor and connection types):	inner polishing
Max. operation time (hours/day):	24
Max. production time for a standard version (if not available in stock) (weeks):	8
Standard packing:	stretch wrap + cardboard box
Other packing modes (surcharged options):	wooden box, maritime packing according to clients needs
Warranty (months):	12

The mentioned flow capacity depends on the type of the cleaned material and is only approximative. This product can be delivered also in other dimensions, in versions with a higher temperature resistance and other kind of magnets etc. upon a special request.