

Datasheet MSP-AC 100 N SHARK

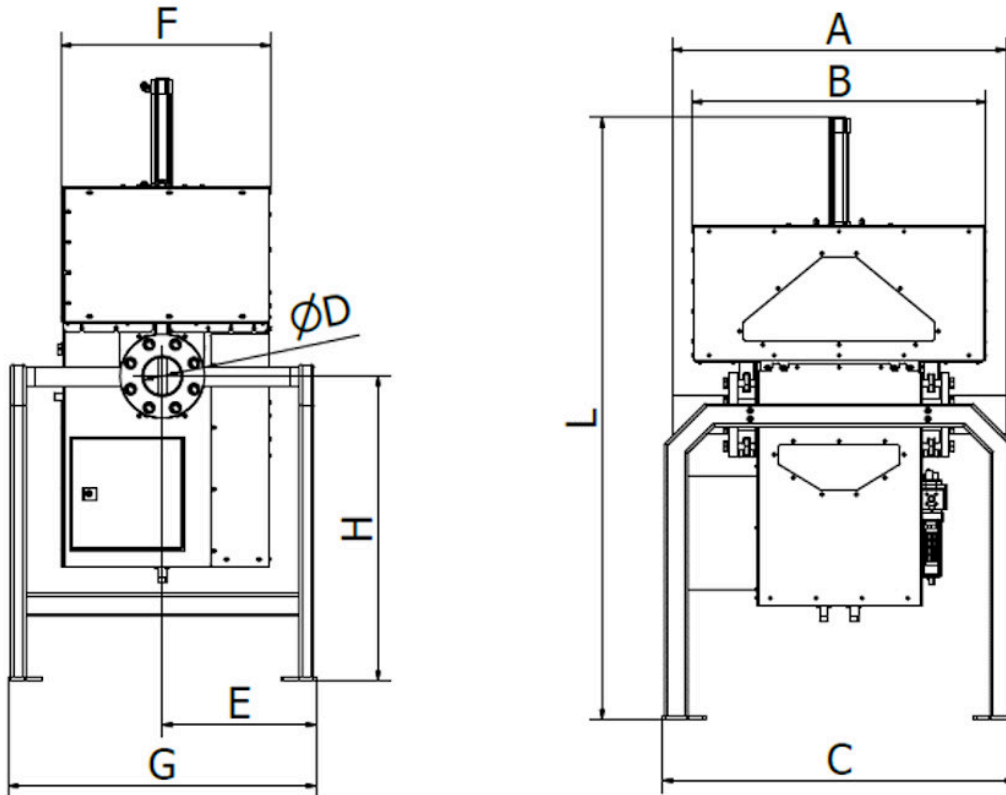

Model		MSP-AC 50 N SHARK	MSP-AC 100 N SHARK	MSP-AC 150 N SHARK	MSP-AC 200 N SHARK	MSP-AC 250 N SHARK
Weight (kg)		195	260	435	620	730
Dimensions (mm)	ØD	50	100	150	200	250
	A	750	850	950	1000	1400
	B	775	775	920	1005	1205
	C	925	925	1055	1155	1555
	G	804	804	1104	1104	1304
	E	402	402	552	552	652
	F	550	550	750	750	950
	H	800	800	1000	1000	1200
L	1395	1585	2125	2425	2925	

Pipeline diameter (inches)	Water (3 bars)	G1/2"	G1/2"	G1/2"	G1/2"	G1/2"
	Air (6 bars)	G1/2"	G1/2"	G1/2"	G1/2"	G1/2"
	Waste	G1/2"	G1/2"	G3/4"	G3/4"	G3/4"
Max. capacity (l/m)	Number of tubes	3 x 32 mm	5 x 32 mm	7 x 32 mm	10 x 32 mm	15 x 32 mm
	Material n. 1	500	1100	6500	6800	6900
	Material n. 2	350	800	4800	4900	5000
	Material n. 3	170	400	2300	2400	2450
	Material n. 4	70	150	1100	1150	1200

Material type	Types of products	Examples
Type 1	Fluid and strained products	Beverages, water, juices, jellies, salad dressings, custard, thin soups
Type 2	Fibrous and crushed products	Crushed fruits, chopped foods, medium syrups, vegetable soups, thick dressings
Type 3	Viscous or heavy products	Thick puddings, creamed cheese, baby foods, frozen slush, heavy sauces, heavy purees, heavy syrup
Type 4	Viscous and fibrous products	Minced meat, pet foods, thick batters, meat spreads, warm preserves, ground meat products

Parameter name	Value
Description:	Self-cleaning pipeline magnetic separator
Separator placement:	inside of a pipeline,
Application (= the material that the application of this separator is suitable for):	liquid material
Material flow direction):	horizontal
Built-in standard magnet type:	neodymium magnet N52
Max. magnetic induction (G) on the surface of tube (+/- 10 %):	12200
Magnetic flux (G) on the magnetic core (+/- 10 %):	18700
Maximum capacity. The mentioned capacities are informative and non binding (m3/h):	66
Weight of the separator (kg):	260

Connecting dimension, inlet and outlet diameter of the separator (mm):	100
Standard connection of the separator:	standard flange
Separator is suitable also even for the materials of poor bulk properties:	no
Minimum size of the particles that can be captured by the separator (mm):	0.03
Max. operating temperature (°C):	80
Min. surrounding ambient temperature (°C):	-25
Max. surrounding ambient temperature (°C):	45
Material of the sealing:	EPDM
Separator is suitable for vacuum or pressure conveying lines:	yes
Separator is suitable for materials transported by:	pipeline
Max. speed at which that the separator can capture ferrous particles (m/s):	25
Separator is able to capture paramagnetic particles:	yes
Separator is suitable for abrasive materials (1 = strongly abrasive, 2 = slightly abrasive, 3 = non-abrasive):	3
Separator is suitable for materials that tend to solidify (the materials must be heated):	no
Separation of non-ferrous metals:	no
Standard requirements for the installation:	compressed air supply (of 6 - 8 bar), water supply (3 bar), electricity supply (230 V, 50 Hz)
Cleaning of the separator:	automatic cleaning, but it is necessary to interrupt the material flow during the cleaning
Diameter of the outer (protective) tube of the magnetic rod (mm):	32
Diameter of magnetic rod (mm):	29
Number of magnetic tubes:	5
System tube in tube:	no
Material of the separator body (that is in contact with the material):	DIN 1.4301
ATEX (on request):	zone 21, 22
Outer surface treatment of the separator:	sandblasted, partially powder coated (RAL colour tone), outer covering made of 11373 steel
Inner surface treatment of the separator:	sandblasting, polished pipes

Magnetic system:	magnetic tube
Degree of motor protection (against dust and water):	IP55
Standard electrical equipment of the separator:	external electric cable with a plug, no frequency convertor, no electric switchboard, pneumatic components FESTO, automatic flaps, automatic spherical valves
Other standard parameters:	control panel made by SIEMENS, colourful touch screen, warning beacon, setting of the cleaning interval, password setting, START/STOP/TEST, separator can be stopped and cleaned anytime, errors reported on LED display made by Siemens, setting of the rinsing time and rinsing intensity, setting of the drying time and drying intensity, pressure resistance up to do 6 bars (no official certificate)
Other additionally paid options:	pressure resistance above 6 bars (with an official pressure certificate), inner polishing, neodymium magnets N52, flowmeter (for rinsing water monitoring), monitoring of the inlet pressure of the treated material(Current pressure), sight glass for pressure above 6 bars, Remote administration (GSM module), Internet (option for GSM), Desilting container with MVS 500 F staging roller (free of wiring system), MVS 500 F electro wiring, DN50 - DN250 butterfly flap (for bypass)
Max. operation time (hours/day):	24
Max. production time for a standard version (if not available in stock) (weeks):	8
Standard packing:	wooden box
Other packing modes (surcharged options):	maritime packing according to clients needs
Warranty (months):	12

The mentioned capacity is only approximative and depends on the type of the cleaned material. This product can be delivered also in different dimensions, in the versions with a higher temperature resistance, different magnets etc. upon a special request. The separator can be installed only in a horizontal position.

- Standard version (without an official pressure certificate): resistant up to 6 bars
- Above standard version (with an official pressure certificate): resistant above 6 bars
- Additional option: official pressure certificate