

Datasheet MSP-S 125 N - OCTOPUS

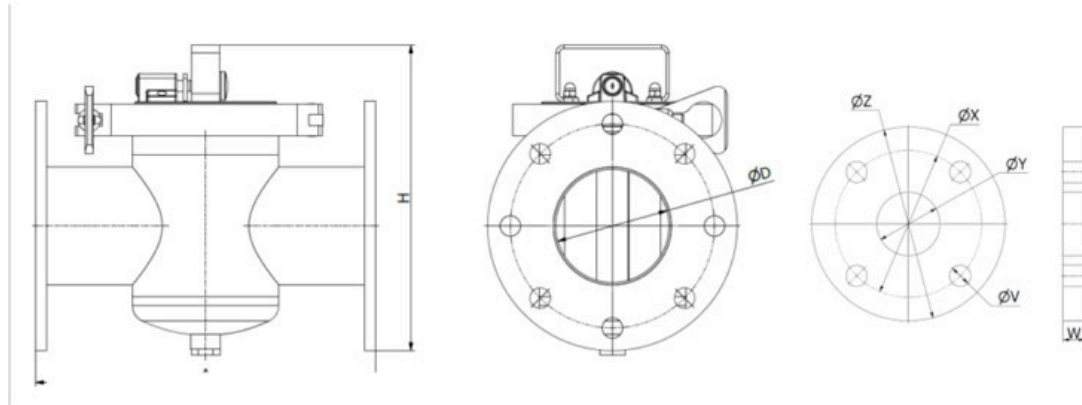

		Dimensions (mm)			
Model	Weight (kg)	A	H	D	Number and type of magnetic tubes
MSP-S 50 N - OCTOPUS	9	240	230	50	3x28 mm
MSP-S 65 N - OCTOPUS	9,5	240	240	66	3x28 mm
MSP-S 80 N - OCTOPUS	15	300	275	80	5x28 mm
MSP-S 100 N - OCTOPUS	17	300	285	100	5x28 mm
MSP-S 125 N - OCTOPUS	28	400	310	125	8x28 mm
MSP-S 150 N - OCTOPUS	32	400	330	150	8x28 mm
MSP-S 200 N - OCTOPUS	45	500	425	200	10x28 mm

Dimensions of standard flanges

		Dimensions (mm)				
Flange type	Number of holes	V	W	X	Y	Z
DN 50	4	18	10	125	50	165
DN 65	4	18	10	145	66	185

DN 80	8	18	10	160	80	200
DN 100	8	18	10	180	100	220
DN 125	8	18	10	210	125	250
DN 150	8	22	10	240	150	285
DN 200	12	22	10	295	200	340

Parameter name	Value
Description:	Pipeline magnetic separator for pressure and vacuum conveying systems
Separator placement:	inside of a pipeline,
Material flow direction (beginning with the most common one):	vertical, horizontal
Max. magnetic induction (depending on the type of the separator it is either a magnetic value on the surface of the separator or a magnetic value that is in direct contact with the treated material. Tolerance +/- 10 %):	9500
Magnetic flux on the magnetic core (G) Tolerance +/- 10 %:	13500
Weight of the separator (kg):	28
Connecting dimension, inlet and outlet diameter of the separator (mm):	125
Application (= the material that the application of this separator is suitable for):	liquid material, semi-fluid material, bulk material
Separator is suitable also even for the materials of poor bulk properties:	no
Minimum size of the particles that can be captured by the separator (mm):	0.03
Maximum size of the particles that can be captured by the separator (mm):	10
Separator is suitable for vacuum or pressure conveying lines:	yes
Separator is suitable for materials transported by:	pipeline
Max. speed at which that the separator can capture ferrous particles (m/s):	25
Separator is able to capture paramagnetic particles:	yes
Separator is suitable for abrasive materials (1 = strongly abrasive, 2 = slightly abrasive, 3 = non-abrasive):	2

Separator is suitable for materials that tend to solidify (the materials must be heated):	no
Separation of non-ferrous metals:	no
Cleaning of the separator:	manual cleaning (with easy cleaning system), it is necessary to interrupt the material flow during the cleaning
Max. operating temperature/ max. temperature of the material (°C):	60
Min. surrounding ambient temperature (°C):	-25
Max. surrounding ambient temperature (°C):	45
Built-in standard magnet type	neodymium magnet N52
Material of the sealing (it regards only some separators):	EPDM
Diameter of the outer (protective) tube of the magnetic rod (mm):	28
Inner diameter (either of the uncovered magnetic cores or of the magnetic rod covered by the first protective stainless steel tube = system tube in tube) (mm):	25
Number of magnetic tubes (it concerns grate type separators only):	8
System tube in tube (it concerns grate type separators only):	yes
Material of the separator body (that is in contact with the treated material):	DIN 1.4301
ATEX specification (number):	20, 21, 22
Outer surface treatment of the separator:	sandblasted
Inner surface treatment of the separator:	sandblasted
Magnetic system:	magnetic tube
Connection possibilities of the separator (the variant mentioned as the first is the standard one):	standard flange, dairy threaded fittings
Other standard parameters:	tri-clamp fittings, welded nipple with a plug (= no ball valve), bayonet lock (to fix the magnetic tubes in the correct position), neodymium magnets N52, sieve (mesh of 10 x 10 mm)
Other additionally paid options (beside the already mentioned options referring to the anti-abrasion protection, motor and connection types):	increased distances between the tubes, inner polishing, polished tubes, tap with a ball valve, magnetic tubes of 25 mm (without the external protective tubes)
Max. operation time (hours/day):	24
Max. production time for a standard version (if not available in stock) (weeks):	8

Standard packing:	stretch wrap + cardboard box
Other packing modes (surcharged options):	wooden box, pallet, maritime packing according to clients needs
Warranty (months):	12

This product is available in two versions: 1) Standard version "tube in tube" (outer pipe diameter is 28 mm) 2) Non-standard version with a magnetic rod of 25 mm (without the external protective stainless steel tube). The separator can be delivered also in different dimensions, with higher temperature resistance, with different magnets upon a special request.