

Datasheet TM 350 N

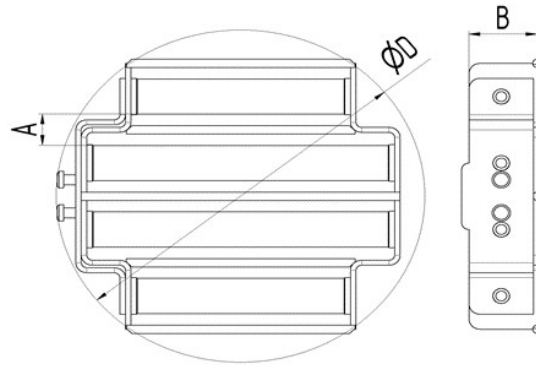

					Dimensions (mm)		
Model	Dispersion cones	Weight (kg)	Max. flow capacity (m ³ /h)	Number of tubes	A	B	D
TM 100 N	YES	0,6	1,5	2	19	37	100
TM 150 N	YES	1,2	3	3	19	37	150
TM 200 N	YES	2	4,5	4	19	37	200
TM 250 N	YES	3	6	5	19	37	250
TM 300 N	YES	4,5	7,5	6	19	27	300
TM 350 N	YES	5,9	9	7	19	37	350
TM 400 N	YES	7,7	10,5	8	19	37	400

Parameter name	Value
Description:	Hopper magnet
Separator placement:	feeding hopper
Application (= the material that the application of this separator is suitable for):	bulk material
Material flow direction):	vertical, horizontal
Built-in standard magnet type:	neodymium magnet N35
Max. magnetic induction (G) on the surface of tube (+/- 10 %):	6000
Magnetic flux (G) on the magnetic core (+/- 10 %):	9000
Maximum capacity. The mentioned capacities are informative and non binding (m ³ /h):	9 m ³ /h

Weight of the separator (kg):	5,9 kg
Connecting dimension, inlet and outlet diameter of the separator (mm):	DN350
Minimum size of the particles that can be captured by the separator (mm):	0,03 mm
Max. operating temperature (°C):	80
Min. surrounding ambient temperature (°C):	-25°C
Max. surrounding ambient temperature (°C):	45°C
Separator is able to capture paramagnetic particles:	yes
Separator is suitable for abrasive materials (1 = strongly abrasive, 2 = slightly abrasive, 3 = non-abrasive):	3
Cleaning of the separator:	manual cleaning with easy cleaning systém (it is necessary to interrupt the material flow during the cleaning)
Diameter of the outer (protective) tube of the magnetic rod (mm):	22 mm
Diameter of magnetic rod (mm):	19,4 mm
Number of magnetic tubes:	7
Material of the separator body (that is in contact with the material):	AISI 304 (DIN 1.4301)
ATEX (paid option):	zone 20, 21, 22
Outer surface treatment of the separator:	sandblasted
Options of the extended anti-abrasion protection:	polishing, chemical nickel coating
Other standard parameters:	fixed dispersion cones
Other additionally paid options:	polished version, version without dispersion cones, cleaning device, magnets with higher temperature resistance
Max. operation time (hours/day):	24
Max. production time for a standard version (if not available in stock) (weeks):	4-6
Standard packing:	cardboard box
Other packing modes (surcharged options):	wooden box, pallet, maritime packing according to clients needs
Warranty (months):	12

The mentioned capacity is only approximative and depends on the type of the cleaned material. If there are used dispersion cones, the distances between the tubes mentioned above are of half values! Even square dispersion cones can be delivered upon a special request.