

Datasheet TM FL 200 N

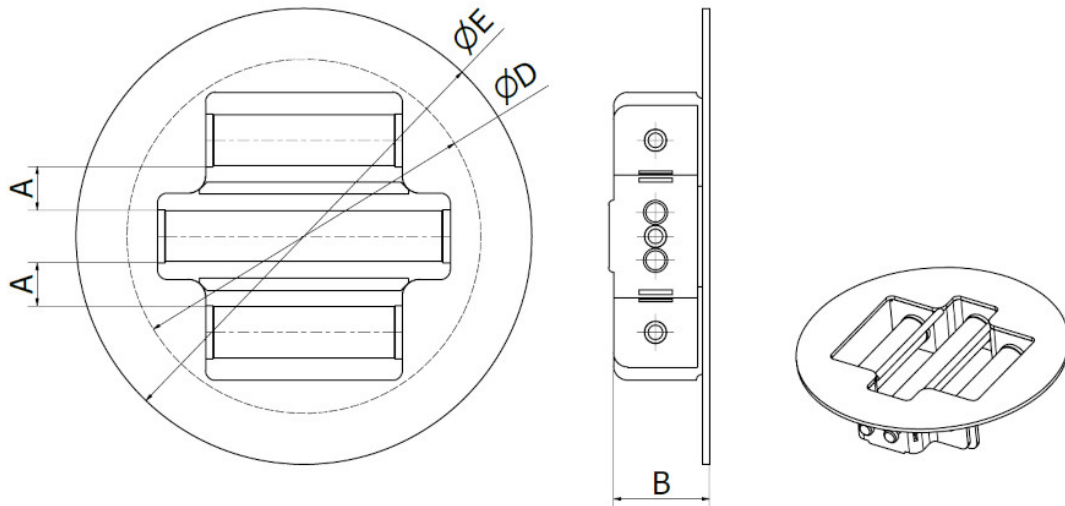

Model	Dispersion cones	Weight (kg)	Max. flow capacity (m ³ /h)	Number of tubes	Dimensions (mm)						
					A	B	X	Y	Z	D	E
TM FL 100 N	YES	0,8	1,5	2	19	40	149	140	220	100	142
TM FL 150 N	YES	1,6	3	3	19	40	152	152	320	150	190
TM FL 200 N	YES	2,6	4,5	4	19	40	205	200	420	200	242
TM FL 250 N	YES	3,7	6	5	19	40	217	245	500	250	290
TM FL 300 N	YES	5,4	7,5	6	19	40	279	290	560	300	347
TM FL 350 N	YES	7,1	9	7	19	40	289	325	620	350	397
TM FL 400 N	YES	9,3	10,5	8	19	40	320	400	800	400	447

Parameter name	Value
Description:	Hopper magnet
Separator placement:	feeding hopper
Application (= the material that the application of this separator is suitable for):	bulk material
Material flow direction):	vertical, horizontal
Built-in standard magnet type:	neodymium magnet N35
Max. magnetic induction (G) on the surface of tube (+/- 10 %):	6000

Magnetic flux (G) on the magnetic core (+/- 10 %):	9000
Maximum capacity. The mentioned capacities are informative and non binding (m3/h):	4,5 m3/h
Weight of the separator (kg):	2,6 kg
Connecting dimension, inlet and outlet diameter of the separator (mm):	DN200
Minimum size of the particles that can be captured by the separator (mm):	0,03 mm
Max. operating temperature (°C):	80
Min. surrounding ambient temperature (°C):	-25°C
Max. surrounding ambient temperature (°C):	45°C
Separator is able to capture paramagnetic particles:	yes
Separator is suitable for abrasive materials (1 = strongly abrasive, 2 = slightly abrasive, 3 = non-abrasive):	3
Cleaning of the separator:	manual cleaning (with easy cleaning system), it is necessary to interrupt the material flow during the cleaning
Diameter of the outer (protective) tube of the magnetic rod (mm):	22 mm
Diameter of magnetic rod (mm):	19,4 mm
Number of magnetic tubes:	4
Material of the separator body (that is in contact with the material):	AISI 304 (DIN 1.4301)
ATEX (paid option):	zone 20, 21, 22
Outer surface treatment of the separator:	sandblasted
Options of the extended anti-abrasion protection:	polishing, chemical nickel coating
Other standard parameters:	fixed dispersion cones, round flange
Other additionally paid options:	polished version, version without dispersion cones, cleaning device, magnets with higher temperature resistance
Max. operation time (hours/day):	24
Max. production time for a standard version (if not available in stock) (weeks):	4-6
Standard packing:	cardboard box
Other packing modes (surcharged options):	wooden box, pallet, maritime packing according to clients needs
Warranty (months):	12

The mentioned capacity is only approximative and depends on the type of the cleaned material. This separator is delivered with a cleaning and storing device. If there are used dispersion cones, the distances between the tubes mentioned above are of half values! Even square dispersion cones can be delivered upon a special request.